



SANWA
TECHNOLOGIES

SC SERIES

Datacom & Telecom Connections

We Create, We Customize, We Connect





SANWA

T E C H N O L O G I E S

Providing engineering excellence, connecting you and beyond.

SANWA Technologies Co., Ltd. (formerly Sanwa Denki Kogyo Co., Ltd.) was established in 1947 and has since become a renowned manufacturer of communication and connectivity solutions, specializing in the global optical communications market. With over 75 years of innovation and engineering excellence, SANWA has developed and manufactured high-quality connectivity solutions and components to enhance the performance of optical networks both today and for the future.

Manufacturers designing products since 1947.

SANWA specializes in optical solutions that serve a broad range of international customers within the Telecom, Enterprise, Datacom, Premise wiring, CATV, OEM, Utility, Municipality, Security, and Aerospace/Military markets. With over 40 years of experience in fiber optic components and passive assembly manufacturing, we offer a variety of products and custom solutions tailored to your needs.

Our Vision

For over 75 years, SANWA has sought to establish relationships that are beyond transactional. Diligently collaborating on both custom and standard products with expeditious local support. Over time, we have transformed the traditional Japanese manufacturing philosophy, Monozukuri, exemplified in our everyday pursuit of manufacturing thoughtfulness, and equally focus on all aspects of product delivery: quality, time, and service.

ADVANCING TOGETHER, FORGING THE FUTURE

At SANWA Technologies, we take great pride in our world-class manufacturing facilities that empower us to deliver high-quality products to our valued customers.

With two state-of-the-art factories, strategically located in Tokyo, Japan, and Ayutthaya, Thailand, we strive for excellence through cutting-edge technology, precision engineering, and a dedicated focus on quality. Each facility serves a unique purpose, allowing us to meet the diverse needs of our global clientele.

Japan Hachioji Factory: Leading Innovation and Research

Our Hachioji factory, nestled in the western part of Tokyo, is the epitome of innovation and research. Equipped with the latest advancements in manufacturing technology, this facility drives our relentless pursuit of excellence. Our team of seasoned experts leads research and product development, ensuring that SANWA Technologies remains at the forefront of industry advancements. The factory also houses a robust QA, QC, and General Qualification Lab, where every product undergoes stringent testing to meet the highest quality standards. With a focus on low-volume and BCP production, as well as automated MT production and active device production, our Hachioji factory is a hub of progress and ingenuity.



Thailand Ayutthaya Factory: Powering High-Volume Production

Nestled in Ayutthaya, Thailand, our second manufacturing facility is a powerhouse dedicated to high-volume production. With a sharp focus on efficiency and precision, this factory houses cutting-edge equipment for high-volume injection molding and precision assembly and testing. Quality is paramount, and our dedicated QA and QC Lab ensures that each product meets our stringent quality guidelines. We also prioritize tooling maintenance and repair, guaranteeing optimal performance and precision throughout the manufacturing process. For critical processes that demand a controlled environment, our Thailand factory boasts a semi-clean room, enabling us to deliver products with unparalleled purity and accuracy.





SC-ELITE™
SC HIGH SPEC
PRE-ASSEMBLED

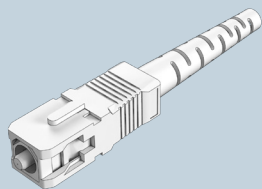

CONNECTOR TYPE		FERRULE I.D.		HOUSING		BOOT		BOOT COLOR	
CN-SC	Low Loss Connector	125	SM: 125µm	1	Blue	1	900µm Smooth Fiber Short	1	Blue
		1255	SM: 125.5µm	2	Black	2	900µm High Spec Slotted	2	Black
		126	SM: 126µm	4	Beige	A	900µm GR-type	3	Green
		127	MM: 127µm	6	Red	12	1.2mm High Spec Slotted	4	Beige
		144	MM: 144µm			3	2.0mm Standard	6	Red
		230	MM: 230µm			4	2.0mm High Spec SC	7	Yellow
						5	2.0mm Smooth Short	8	White
						M	2.0mm Slotted Mini	0	Gray
						6	2.4mm Smooth Short		
						7	3.0mm Smooth Short		
						8	3.0mm Standard		
						9	3.0mm High Spec SC		
						N	3.0mm Slotted Mini		

SC-ELITE™ APC
SC HIGH SPEC APC
PRE-ASSEMBLED

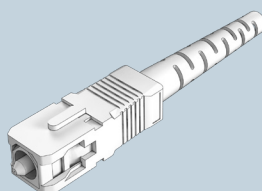

APC FERRULE TYPE		FERRULE I.D.		ANGLE		BOOT	
CN-SCAS	Step	125	SM: 125µm	1	No Angle	1	900µm Smooth Fiber Short
CN-SCAC	Conical	1255	SM: 125.5µm	2	8° Pre-Angle	2	900µm High Spec Slotted Boot
		126	SM: 126µm			A	900µm GR-type
						12	1.2mm High Spec Slotted Boot
						3	2.0mm Standard Boot
						4	2.0mm High Spec SC Boot
						5	2.0mm Smooth Short Boot
						M	2.0mm Slotted Mini Boot
						6	2.4mm Smooth Short Boot
						7	3.0mm Smooth Short Boot
						8	3.0mm Standard Boot
						9	3.0mm High Spec SC Boot
						N	3.0mm Slotted Mini Boot

SC PM CONNECTOR
PRE-ASSEMBLED

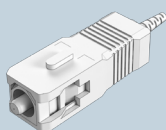

SERIES		FERRULE I.D.		HOUSING		BOOT DIAMETER		BOOT COLOR	
SSC-P	PM SC Connector	1255S	SM 125.5µm	BL	Blue	09	900µm Boot	BL	Blue
		1255AP	APC 125.5µm	GR	Green	20	2.0mm Boot	GR	Green
						30	3.0mm Boot		

SC DUPLEX
UNIVERSAL CLIP

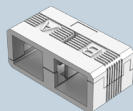

CODE / CONNECTOR TYPE		TYPE		COLOR	
CN-SCCS	SC Duplex Clip for Standard Connector	H	High Spec	1	Blue
		S	Standard	2	Black
				3	Green
				4	Beige
				6	Red





CONNECTOR TYPE		FERRULE I.D.		HOUSING		BOOT		BOOT COLOR	
CN-SCPA	Pre-assembled	1255	SM: 125.5µm	1	Blue	1	900um Smooth Fiber Short	1	Blue
CN-SCUK	Unassembled kit	127	MM: 127µm	2	Black	3	2.0mm Standard	2	Black
		000	No Ferrule	4	Beige	8	3.0mm Standard	4	Beige
								5	Aqua

SC STANDARD

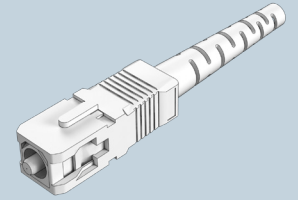

CODE	OUTER HOUSING		BOOT		BOOT COLOR		
CN-SCK	A	Blue with White line	1	900um Smooth Fiber Short Boot	1	Blue	
	B	Black with White Line	3	2.0mm Standard Boot	2	Black	
	C	Beige with White Line	8	3.0mm Standard Boot	3	Green	
	D	Green with White Line			4	Beige	
						6	Red

SC CONNECTOR KIT NTT STYLE

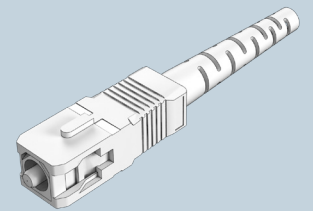

CODE	FERRULE I.D.		HOUSING		BOOT DIAMETER		BOOT COLOR	
SSCFA-2PHPR	1255S	SM 125.5um	BL	Blue	09	900um Boot	BL	Blue
	1255AP	APC 125.5um	GR	Green	20	2.0mm Boot	GR	Green
	127M	MM 127um	BE	Beige	30	3.0mm Boot	BE	Beige

SC UNIBOOT CONNECTOR PRE-ASSEMBLED

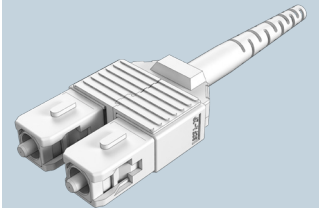

CODE	FERRULE I.D.		HOUSING		BOOT DIAMETER		BOOT COLOR		
SSCASG-PHPR	Pre-assembled	125S	125um	WH	White	30	3.0mm Boot	-	Light Gray
		1255AP	125.5um (standard)	BL	Blue			GR	Green
				GR	Green				

SC AUTO SHUTTER CONNECTOR PRE-ASSEMBLED

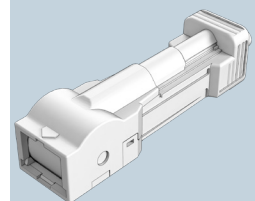



SC ADAPTER
SIMPLEX

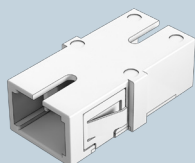

CODE	TYPE		COLOR		SLEEVE TYPE		FLANGE	
AD-SC	SX	Simplex	1	Blue	1	Zirconia Ceramic	NF	No Flange
	SX1P	One Piece Simplex	2	Black	2	Phosphor Bronze	FL	Flange
			3	Green	3	Elite Zirc. Ceramic (Ultra Low Loss)		
			4	Beige				
			5	Aqua				

For Adapters with Shutters, please add:
 -ESH to the end of the part number for External shutter installed
 -ISH to the end of the part number for Internal shutter installed

SC ADAPTER
DUPLEX

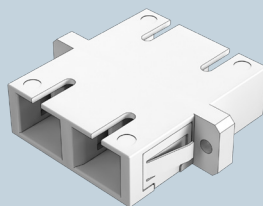

CODE	TYPE		COLOR		SLEEVE TYPE		FLANGE	
AD-SC	DX	Duplex	1	Blue	1	Zirconia Ceramic	NF	No Flange
	DX1P	One Piece Duplex	2	Black	2	Phosphor Bronze	FL	Flange
			3	Green	3	Elite Zirc. Ceramic (Ultra Low Loss)		
			4	Beige				
			5	Aqua				

For Adapters with Shutters, please add:
 -ESH to the end of the part number for External shutter installed
 -ISH to the end of the part number for Internal shutter installed

SC SNUG FIT

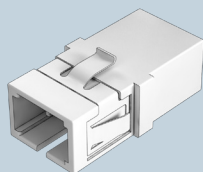

CODE	TYPE		COLOR		SLEEVE TYPE	
AD-SCSF	SX	Simplex	1	Blue	1	Zirconia Ceramic
	DX	Duplex	2	Black	2	Phosphor Bronze
			3	Green	3	Elite Zirc. Ceramic (Ultra Low Loss)
			4	Beige		
			5	Aqua		

For Adapters with Shutters, please add:
 -ESH to the end of the part number for External shutter installed
 -ISH to the end of the part number for Internal shutter installed

SC LOOPBACK
MODULES

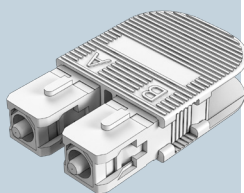

CODE	TYPE		CONNECTOR TYPE		FIBER		COLOR	
LB-SCK	SM	Singlemode	AA	SC/UPC	9	900µm Fiber	S	Transparent
	MM	Multimode	BB	SC/APC			2	Black MM





CODE	TYPE		SLEEVE TYPE	
AD-SC	SXMT	Simplex	1	Zirconia Ceramic
	DXMT	Duplex	2	Phosphor Bronze
			3	Elite Zirc. Ceramic (Ultra Low Loss)

SC METAL ADAPTER

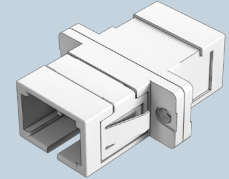

CODE	TYPE	COLOR	SLEEVE TYPE	FLANGE	
SSC131B	1A-SH	BL	Blue	ZR Zirconia	NF No Flange
		GR	Green		
		WH	White		

SC SHUTTER ADAPTER

SC auto shutter connectors ONLY

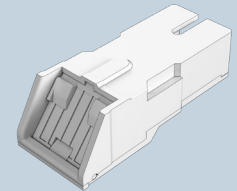

CODE	TYPE		COLOR	SLEEVE TYPE	FLANGE	
SSC131B-1ASP	SK-2SH	SX Horizontal Shutter	BL	Blue	ZR Zirconia	NF No Flange
SSC131B-2ASP	SK-2SH	DX Horizontal Shutter	GR	Green		
			AQ	Aqua		
			HV	Heather Violet		

SC ALL IN ONE ADAPTER

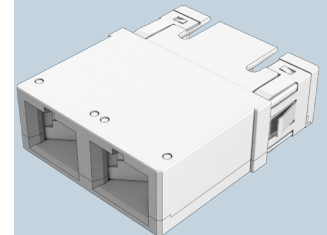

CODE	TYPE	COLOR	SLEEVE TYPE	FLANGE	
SSC135B-1A	SX Vertical Shutter	BL	Blue	ZR Zirconia	NF No Flange
		GR	Green		FL Flange
		AQ	Aqua		
		HV	Heather Violet		

SC ALL IN ONE ADAPTER VERTICAL SHUTTER

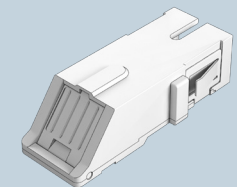



ATTENUATORS
& TERMINATORS

ATTENUATORS

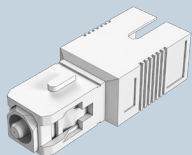

CODE		TYPE		CONNECTOR TYPE		ATTENUATION LEVEL	
AT	Doped Fiber Attenuators	1	Standard	SCA	SC APC	01	1dB
		2	Special	SC	SC UPC	03	3dB
		S	Specify			04	4dB
						05	5dB
						07	7dB
				08	8dB		
				09	9dB		
				10	10dB		
				12	12dB		
				15	15dB		
				20	20dB		
				25	25dB		
				30	30dB		

TERMINATORS

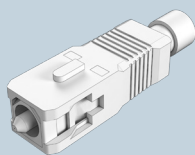

PRODUCT	CONNECTOR TYPE	
TM	SC	SC UPC
	SCA	SC APC

HYBRID ADAPTER

SC-ST HYBRID ADAPTER

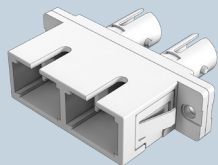

CODE/ADAPTER TYPE		COLOR (PLASTIC)		SLEEVE	
ADH-SCST-RT-M	Simplex Metal, Rectangular Flange	1	Blue	1	Zirconia
ADH-SCSTDX-M	Duplex Metal, Rectangular Flange	4	Beige	2	Phosphor Bronze
ADH-SCSTDX-P	Duplex Plastic, Blue, Rectangular Flange				
ADH-SCSTDX-P	Duplex Plastic, Beige, Rectangular Flange				

SC-FC HYBRID ADAPTER

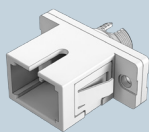

CODE/ADAPTER TYPE		KEY WIDTH		SLEEVE	
ADH-SCFC-SQ	Square Flange	1	For PC Connector: 2.15+0.05/-0	1	Zirconia
ADH-SCFC-RT	Rectangular Flange	2	For APC Connector: 2.05 +/- 0.02	2	Phosphor Bronze

SC-LC HYBRID ADAPTER

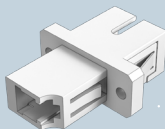

CODE	SLEEVE	
ADH-LCSC	1	Zirconia





FERRULE		INNER DIAMETER		FLANGE	
F-SC-S	SC & FC Connectors Singlemode	125	125µm	NF	No Flange
		1255	125.5µm	FL	4 Slot Flange
		126	126µm		

ZIRCONIA FERRULES
SC, FC SINGLEMODE

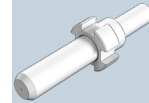

FERRULE		ENDFACE		INNER DIAMETER		FLANGE	
F	SC & FC Connectors	SCAS	APC Step	125	125µm	NF	No Flange
		SCAC	APC Conical	1255	125.5µm	FL	APC Flange, 1.35mm keywidth
				126	126µm		

ZIRCONIA FERRULES
SC-APC, FC-APC

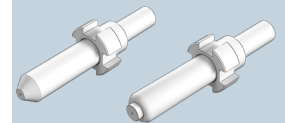

FERRULE		INNER DIAMETER		FLANGE	
F-SC-M	SC & FC Connectors Multimode	127	127µm	NF	No Flange
		144	144µm	FL	4 Slot Flange
		230	230µm		

ZIRCONIA FERRULES
SC, FC MULTIMODE

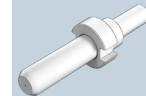

SLEEVE		INNER DIAMETER		LENGTH	
S-ZR	Zirconia Sleeve	250	2.49mm	ST	10.1mm ST
				SC	10.4 SC&FC

ZIRCONIA
ADAPTERS SLEEVES

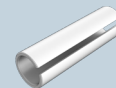



SC BOOTS

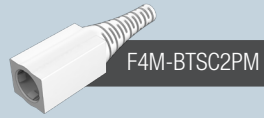

F4M-BTSC2PM



F4M-BTSC3PM



F4M-BTSC9PM



F4MBTPCN-DM

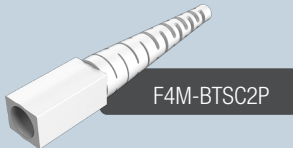

F4M-BTSC2P

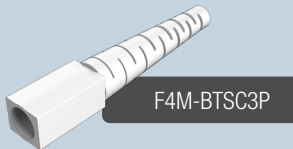

F4M-BTSC3P

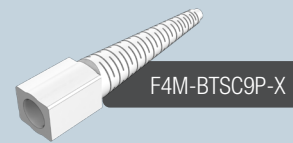

F4M-BTSC9P-X

MINI BOOTS

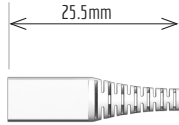

BTSC2PM
SC 2.0mm Mini Boot for 3.8mm backpost

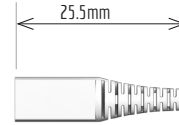

BTSC3PM
SC 3.0mm Mini Boot for 3.8mm backpost

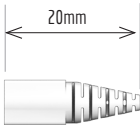

F4M-BTSC9PM
SC 0.9mm Mini Boot for 3.8mm backpost

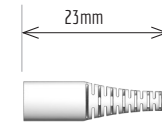

F4M-BTPCN-DM
SC/ST/FC 2.0mm Mini Boot for 3.8mm Backpost

PREMIUM SC BOOTS

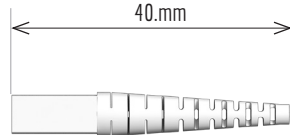

F4M-BTSC2P
2.0mm Premium SC Boot

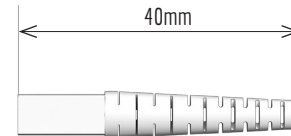

F4M-BTSC3P
3.0mm Premium SC Boot

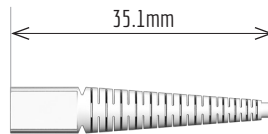

F4M-BTSC9P-X
900um Smooth Fiber Short SC Boot

BOOT COLOR	
1	Blue
2	Black
3	Green
4	Beige
5	Aqua
6	Red
7	Yellow
8	White
0	Gray

SC BOOTS (SPECIFIC)	
F4M-BTSC9P	900um GR-type SC Boot
F4M-BTSC12P	1.2mm Slotted SC Boot
F4M-BTSC2P	2.0mm High Spec SC Boot
F4M-BTSC2PM	2.0mm Slotted SC Mini Boot
F4M-BTSC3PM	3.0mm Slotted SC Mini Boot
F4M-BTSC3P	3.0mm High Spec SC Boot





SC BOOTS

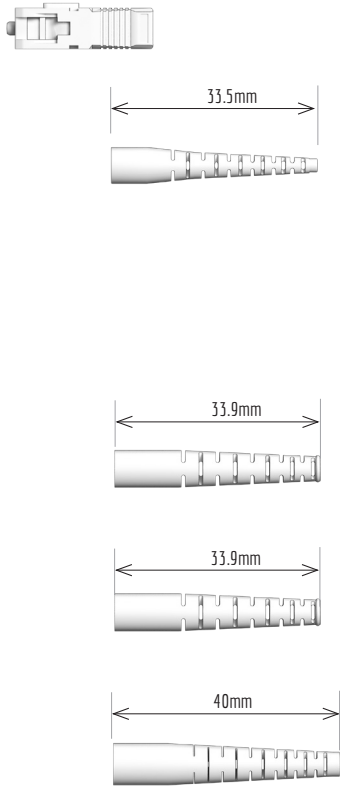

FC BOOTS

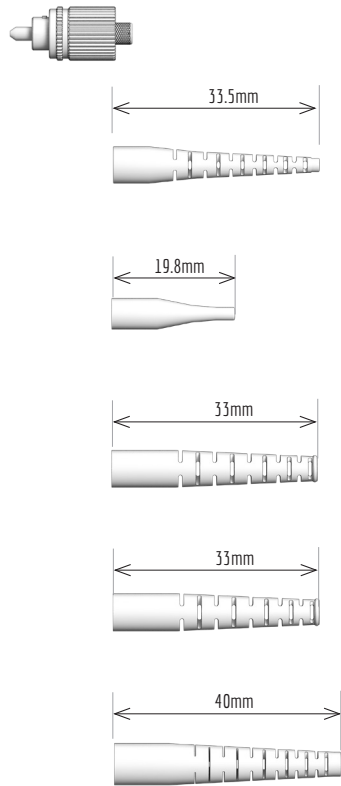

ST BOOTS

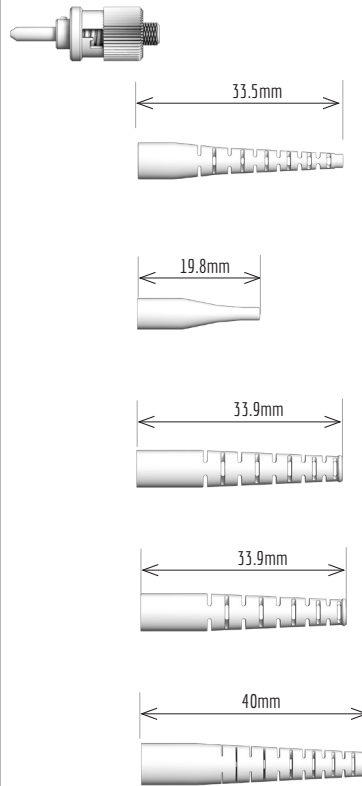

F4M-BT9P

900um premium SC/FC ST/Boot

F4M-BTPCN-A

900um Smooth Fiber Short SC/FC/ST Boot

F4M-BTPCN-D

2.0mm Standard SC/FC/ST Boot

F4M-BTPCN-H

3.0mm Standard SC/FC/ST Boot

F4M-BTFCST3P

3.0mm premium SC/FC ST/Boot

STANDARD BOOTS	
BOOT CODE	DESCRIPTION

SC / FC / ST BOOTS	
F4M-BTPCN-A	900um Smooth Fiber Short SC/FC/ST Boot
F4M-BTPCN-D	2.0mm Standard SC/FC/ST Boot
F4M-BT2S	2.0mm Smooth Short SC/FC/ST Boot
F4M-BT24S	2.4mm Smooth Short SC/FC/ST Boot
F4M-BT3S	3.0mm Smooth Short SC/FC/ST Boot
F4M-BTPCN-H	3.0mm Standard SC/FC/ST Boot
F4M-BTFCST3P	3.0mm High Spec SC/FC/ST Boot

CRIMP RING, PREMIUM SC/FC/ST	
F4M-CR12-P	1.2mm
F4M-CR16-P	1.6mm
F4M-CR2-P	2.0mm
F4M-CR24-P	2.4mm
F4M-CR3-P	3.0mm

1.6mm Option: SANWA TECH Offers a 1.6mm Crimp Ring that is compatible with all 2.0mm boots listed above.

BOOT COLOR	
1	Blue
2	Black
3	Green
4	Beige
5	Aqua
6	Red
7	Yellow
8	White
0	Gray



	TIA/EIA,IEC& GR-326-CORE	RoHS & REACH
Simplex Connectors	•	•
Duplex Connectors	•	•
Uniboot Connectors	•	•
Auto Shutter Connectors&Adapters	•	•
PM Connectors	•	•
SC Adapter Series	•	•
Attenuators	GR-910-CORE	•
Shutters		•

SANWA's SC type optical fiber connector is compatible to NTT SC type optical fiber connector which is used widely for optical subscriber's transmission system. The performance is equal to FC type optical connector for single mode and multi mode transmission. SC type is applying push-pull and square non-rotation type connection.

The plug is available to connect in one touch to adaptor or receptacle. By employing crimping type for aramid strength member and jacket of optical fiber, SC type accomplishes better productivity and economy.

Application

- LAN, CATV, FA, OA general system's equipment
- Medium and long distance optical fiber transmission lines
- Subscriber's optical fiber transmission lines

OVER THE WORLD

SANWA product selection offers a wide range of high-quality and reliable solutions for various applications. Fiber optic technology is known for its ability to transmit data at incredibly fast speeds over long distances, making it ideal for telecommunications, networking, and data center environments.



- USA
- EUROPE
- MIDDLE EAST
- TAIWAN
- THAILAND
- JAPAN



SANWA Technologies, Inc.

www.sanwa-tech.com

sales@snwtech.com

Americas Sales-TX
 4012 Preston Rd.
 Plano, TX 75093
 Tel: +1 (972)-503-3031
 Fax: +1 (972)-503-3032

Americas Sales-MA
 287 Turnpike Road
 Westborough, MA 01581
 Tel: +1 (508)-616-9500
 Fax: +1 (508)-616-9600

Europe Sales
 Aleja Armii Krajowej 61, Bud. C,
 50-541 Wroclaw, PL
 Tel: +48 71 7277237
 Fax: +48 71 7939911

MEA Sales
 DP A6, 108, Silicon Oasis Free
 Zone Dubai,
 United Arab Emirates
 Tel: +971 4 3344970
 Fax: +971 4 3344971

Asia Sales
 13F, Changxing Rd., Luzhou Dist.,
 New Taipei City 247, Taiwan
 (R.O.C.)
 Tel: +886 939512000
 Fax: +886 2 8285450

Catalog 2024

All information provided in this document is subject to legal disclaimers. SANWA Technologies, Inc. © 2023. All rights reserved.

